



Intec FB9550 Pro-T Automatic Die Cutter

Intec FB9550 Pro^T



Automated, high demand **cutting** and **creasing** with exceptional media control.

Exceptional media control

The FB9550 Pro^T is a fully automated, tangential creasing and cutting digital die-cutter engineered for lightning-fast production, exceptional media control and an intuitive, high-performance workflow, bringing professional finishing within effortless reach. At its core, the FB9550 Pro^T features 5 (five) versatile tools, each designed to handle a wide range of applications with remarkable precision and consistency. From complex packaging prototypes to point-of-sale displays and professional labels, every job is finished to the highest standard.

Incorporating the latest technology, including patented back-mark reading, the ultra-fast FB9550 Pro^T ensures every printed board is finished with accuracy and confidence. Designed for today's demanding designers, printers, and manufacturers, it delivers the speed, control, and reliability modern production requires.

With creasing and cutting forces of up to 2.5kg and the capability to process media from thin self-adhesive label stock and boards up to 3,000 microns thick, the FB9550 Pro^T offers exceptional capability for even the most demanding production environments.

Market leading features

- **Unique 5 tool head, 3 concurrent operations** - tangential and passive tools support die cutting, creasing, perforation, debossing and kiss cutting, simultaneously in one single pass
- **Digital process** allows cutting and creasing for any shape or design from one sheet to another automatically
- **QR code driven workflow** - simple to operate using the QR code file retrieval for mixed or batch job production
- **SmartMark registration** delivers incredible accuracy using ColorCut Pro software, supplied with the system
- **Fully optimised feed system** - advanced sheet separation processes, allow accurate and trouble free feeding, for fully unattended operation
- **Sheet pre-placement** - whilst cutting and creasing, the FB9550 Pro^T will place the next sheet ready for production. This reduces the feed time and boosts productivity making the FB9550 Pro^T one of the fastest systems available
- **Patented Rear Mark Scanning System** - optimise your creasing quality for certain jobs by creasing the back of the sheet without having to print marks or QR codes on both sides
- **2.5kg of creasing and cutting pressure** - more pressure produces deeper more defined creases for a high quality finish
- **Ultimate material control** - process thin self-adhesive label stocks and media up to 3mm thick with complete confidence

FIVE TOOL HEAD

- Up to 1200mm/sec speed
- Tangential wheel creaser - Up to 2.5kg force
- Tangential blade holder - Up to 2.5kg force
- Contour cutter - Up to 1.3kg force
- Contour crease - Up to 2.5kg force
- Contour blade holder - Up to 2.5kg force



Automatic Sheet-Fed Flatbed Cutter/Creaser

High-capacity and ultra-reliable feeding

The FB9550 Pro^T is designed to provide high quality production with unattended operation. Unlike other cutters the Intec FB9550 Pro^T incorporates five separate processes to ensure accurate feeding, separation and placement.

- Adjustable suction arm allows faultless sheet acquisition
- Automatic air blade prevents sheet curl
- Sheet feeder lowers to aid sheet collection
- Separation fingers ensure smooth sheet separation
- Jogging* during sheet placement relieves static cling

*Patent pending

Patented rear scanning system

The FB9550 Pro^T can read registration marks from either side of the sheet, allowing accurate cutting even when users print on only one side of the media and the sheet is placed face down. This is especially important for fluted board, where the crease must fold toward the depression; rear scanning ensures correct folding direction without requiring double-sided printing, preventing artwork from being folded into the box.

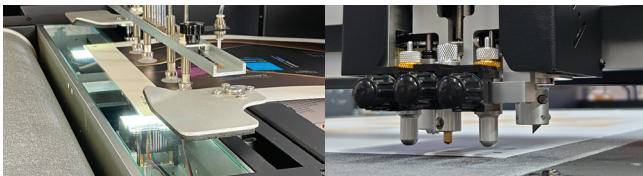

Powerful & flexible five tool operation

The powerful and flexible 5-tool cutting head features two tangential and three passive tools in a 2+2+1 configuration. With selectable active or passive options in the first two positions and a passive tool in the third, it enables up to three simultaneous operations - such as cutting, perforating and creasing or cutting, creasing and debossing - for efficient, multi-process production.

The FB9550 Pro^T's 5 tool head handles everything from high-volume sheet label production to N, G, F and E fluted board up to 3mm thick. This versatile tool set enables efficient processing across a broader range of media types.

The individual tool actions are controlled by the ColorCut Pro 5 Production Studio software supplied with the FB9550 Pro^T. Pressure, speed and cut type can be precisely adjusted for each tool.

Tangential technology enables the FB9550 Pro^T to lift the tool away from the media, rotate it and place it back on the media. This type of creasing tool provides a **smooth and more defined crease** and is particularly good for **thicker media**.

New Ai control for ultimate optimisation

The FB9550 Pro^T is powered by our next generation Ai platform, introducing a suite of innovative features that redefine what automated cutting systems can achieve. Operators can customise a wide range of parameters - including belt speed and acceleration, page separation (jog), gravity restack and more - ensuring optimum performance for every job.

Designed for total workflow flexibility, the system supports both simple manual operation and fully autonomous production. Users can select from the two cutting modes:

DIRECT mode. Offering exceptional control direct from your PC, DIRECT mode allows real time creation. The ColorCut Pro 5 software plug-in automatically assigns a unique QR code to each design while saving the corresponding cut file to the ColorCut library for instant retrieval.

HELD mode. Ideal for manufacturing environments, HELD mode stores job parameters in a single custom file that can be transferred via a storage device such as a USB memory stick. Once inserted into the cutter, jobs can be accessed directly from the main touchscreen - removing the need for a connected PC.

In both modes the cutter reads the QR code, retrieves the correct cut file and proceeds to cut and crease with precision - even if the sheet is inadvertently loaded in the wrong orientation.



Simple, ergonomic touch screen control

The 7" immersive touchscreen puts full control at your fingertips, providing instant visual feedback through the live camera. Its feature-rich interface offers advanced functionality to maintain exceptional quality, accuracy and productivity.

Combined with its compact footprint and adjustable collection tray, the FB9550 Pro^T integrates effortlessly into even the most demanding production environments.

Tools and Accessories

A comprehensive range of tools and accessories, made for ColorCut.

A full range of original manufacturer parts and accessories are available for after-market purchase. Spares can be purchased at time of ordering the flatbed and/or shipped overnight as and when required.

Tangential Tools (active)

Creasing wheel tool. Active Tangential Creasing Wheel tool with options available for different material types.



- Standard Wheel (provided with cutter)**
- FB-UMAGT-00W1** - Tangential Wheel Holder includes tangential wheel 1 for E/F fluted boards
 - FB-UMAGT-00W2** - Tangential Wheel Holder includes tangential wheel 2 for N fluted, FBB/SBS/SBB packaging boards



- Optional Wheels (not included with cutter)**
- FB-UMAGT-08A** - Tangential Creasing tool - Narrow 0.28mm
 - FB-UMAGT-08B** - Tangential Creasing tool - Medium 0.55mm
 - FB-UMAGT-08C** - Tangential Creasing tool - Wide 0.95mm

Perforating tool. Active Tangential perforating wheel.



- Optional (not included with cutter)**
- FB-UMAGT-10A** - Tangential Perforating Wheel tool - 1.68mm pitch

Cutting tool. Active Tangential Cutting tool to hold a 45° blade. Blades shown are purchased separately. *See cutting blades section below.*



- Standard (provided with cutter)**
- FB-UMAGT-03A** - Tangential Blade Holder

Cutting blades

Tangential blades. 45° 5.5mm blade for heavier / thicker stocks up to 3mm. Pack of 3 *provided with cutter.*

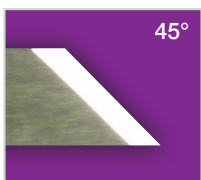

- Stock codes**
- FBBLT45** - Tangential blades - Pack of 3
 - FBBLT45-K15** - Tangential blades - Pack of 15

Drag blades. These ultra-sharp and hard-wearing swivel/drag blades come in two types and three blade angles. Either as a pack of three the same or as a mixed pack.

Blades for kiss cutting/half cut:

- | | | | | |
|---------------|---|--|---|--|
| Yellow | 30° 1mm ø - for film, very soft material, thin label material | | 1 | |
| Red | 45° 1mm ø - typically for labels, stickers, and thin paper/card | | 2 | |
| Blue | 60° 1mm ø - for hard media. The sharply angled tip provides a sharper point edge. Suitable for penetrating harder media types | | 3 | |

Circlip blades for die cutting:

- | | | | | |
|-------------|---|--|---|--|
| Red | 45° 1.5mm ø - Most packing board up to 750 micron. Circlip provides better pressure and improves blade direction changes on dense media, from 0.25 to 0.75 mm thick | | 4 | |
| Blue | 60° 1.5mm ø - For dense, rigid or thick media. Sharply angled tip provides a sharp point ideal for polyester, PVC or magnetic materials. 0.25 to 1.2mm | | 5 | |

Drag Tools (passive)

Creasing tool. Passive ball creasing tools; one narrow and one wide for different media or crease widths. Can also be used to highlight features by 'debossing'. *Both provided with cutter.*



- Standard (provided with the cutter)**
- FBT0007** - Passive Drag Creasing tool - Wide
 - FBT0008** - Passive Drag Creasing tool - Narrow

Cutting tool. Passive Blade Holder tool to hold the cutting blade of choice. The tool is manually adjustable to obtain the desired amount of 'blade out' for the job in hand. *See cutting blades section.*



- Standard (provided with cutter)**
- FBBLHOL** - Passive Contour / Drag Blade Holder tool

Universal tools and accessories

Cutting mat. This replaceable grey felt mat is ideal for achieving crisp cuts and deep creasing lines on a wide range of substrates. The natural density of the fibres allows the vacuum flow to pass through it for sheet retention. The innovative 'jigsaw' style joint makes it easy to replace.



Vacuum pump and silencer. Powerful 750W vacuum pump with acoustic housing and safety valve.

Acoustic silencer. Reduces sound level of vacuum pump. Provided with vacuum fan.



ColorCut Pro Software

How does ColorCut Pro work?

Productivity controls for production runs. With the auto-feeder, ColorCut Pro can cut a specific number of copies or continue to run until all sheets have been cut. In manual mode, multiple sheets can be placed on the table and ColorCut Pro can be set to search for each sheet and cut it - improving productivity. For complex designs it is possible to change the cutting sequence and order.

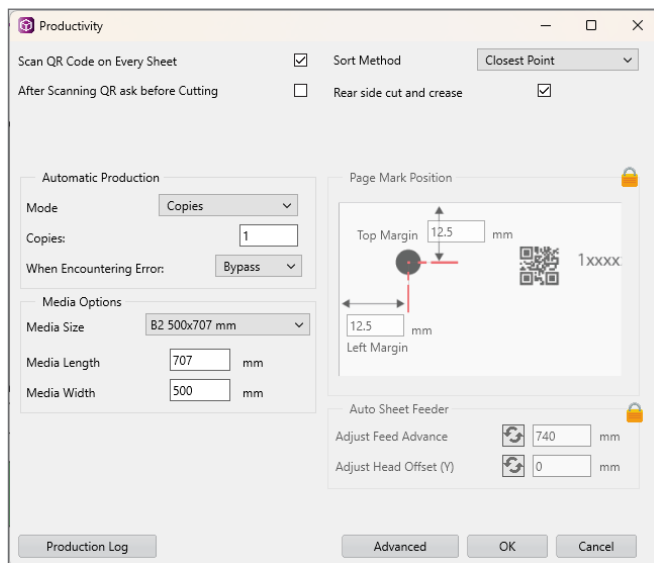

Material database. It's possible to assign a tool (either cutting or creasing), with tool speed and pressure for each action or material used. Settings can be saved so users can quickly and easily recall them in future. Using the 'SmartLine' Colour from the design that has been recognised by ColorCut Pro, assign the material process i.e. cutting 600 micron board, creasing, scoring or perforation.

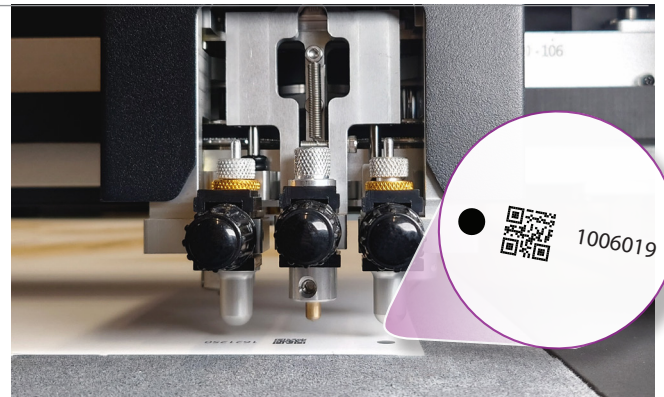
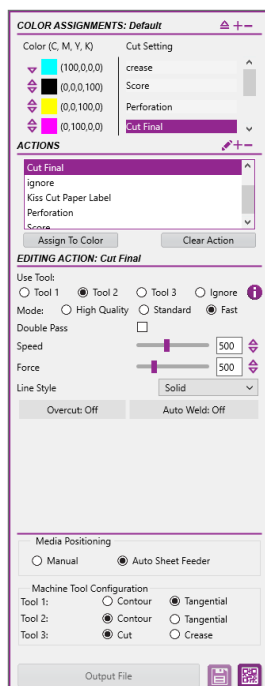

Colour recognition. Working with vector lines in the design, it is possible to set-up cutting/creasing processes using different line Colours. This feature recognises different colours and allows users to set types of operation and the processing sequence, by Colour.

Auto find jobs using QR codes. When a designer uses the ColorCut Pro plugin to automatically add page registration marks, a QR code, job number and cut files are created and saved directly to the ColorCut Pro's Job Library. Once a job has been created with a QR code you benefit from faster, automated retrieval of the cut file at any required point.

In addition, the stand-alone version of ColorCut Pro can be installed on different computers, enabling other team members to cut the jobs - perhaps in another location - simply by using the QR code of the assigned job number.

SmartLine control. Solid lines can be over-riden in designs, turning them into dashed lines, perforated cuts or even small tags to hold designs into the cut sheet.

Click start. Once positioned on the first registration mark, the Vision3 camera will automatically detect the 2nd, 3rd and 4th mark, the ColorCut Pro software automatically compensates for any scale, skew or position errors, allowing cutting to start automatically.

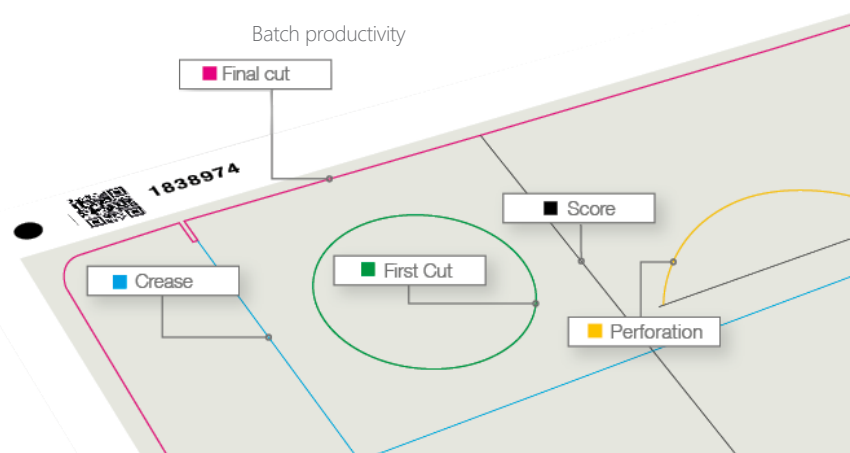

ColorCut Pro Server Station

The optional **ColorCut Pro Server Station** streamlines **production workflow** and automates **productivity**.

ColorCut Pro's client application is a plug in, that fully integrates with the leading drawing packages; Adobe® Illustrator® (Mac and PC) and CorelDRAW® (PC only).

ColorCut Pro - Production Studio, The core application for production and operating of the cutter. A stand alone application which stores cut files and enables users to cut previously prepared jobs, either by recalling the job number or by reading the QR code. Conveniently, ColorCut Pro's Job Library Server, can be used on PC's in remote production departments.

Software and hardware. Everything is designed to work together. Our Vision3 CCD Camera Registration System is integrated into the Intec FB9550 Pro-T to read registration marks and detect the position of sheets on the cutting table.

Create. ColorCut Pro is fully integrated, as a plugin, with Adobe® Illustrator® and CorelDRAW®, allowing users to edit, customize and export designs for use with ColorCut.

ColorCut Pro's Job Library Manager: Adds a sophisticated level of control enabling custom job naming and identification, searching, viewing and even assigning unique or custom actions to specific QR codes or job numbers (only available with the ColorCut Pro Server Station).

Template Maker: Create die-cut templates for a range of simple cartons and shaped items, with your own dimensions, in just a few seconds. This intuitive program allows for a wide range of options to tailor X, Y, Z dimensions, flaps, tucks, creasing and perforations etc. Templates can then be exported to Adobe Illustrator or CorelDRAW for immediate use. Template Maker is also only available with the server station.

Skew compensation: ColorCut Pro has an advanced feature to compensate for print skew or positioning skew. The Vision3 Registration Camera will read QR codes applied to printed files, and retrieve the cutting files from the ColorCut Pro Job Library database.

Contour cutting: Contour cutting involves placing a drawn outline around an object and using the Intec ColorCut flatbed to cut it.



The **Server Station** is supplied complete with a pre-installed Windows® PC and ColorCut Pro software suite, with a flat screen, monitor, mouse and keyboard.



Production Studio is the core operating software



Template Maker enables designers to create simple cartons and a variety of shaped items



Job Library Manager sophisticated job management, with custom action assignment.



User Licence allows 2 extra user seats

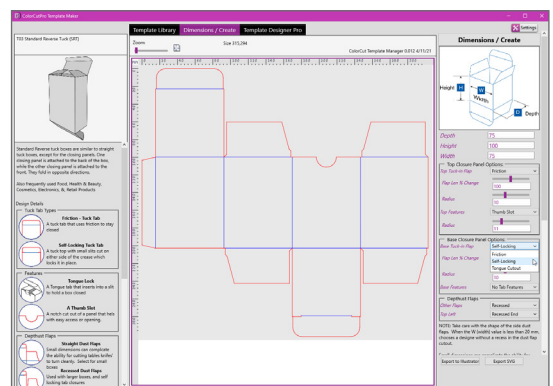
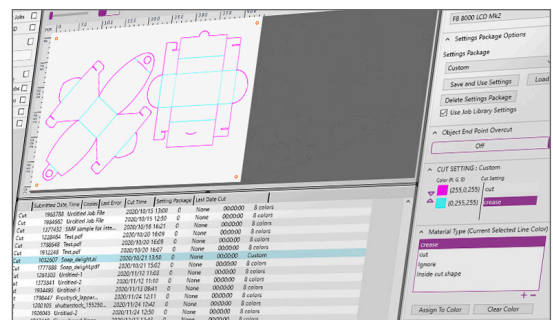

Technical Specification

FB9550 Pro[†] Technical Specifications

CUT AREA	Auto Sheet Feed	Manual placement
Maximum media size	530mm x 740mm	550mm x 850mm
Effective contour cutting area	520mm x 720mm	520mm x 760mm (no mark scanning)
Media placement	Automatic sheet feeder or manual placement	
Media hold-down method	2 zone vacuum bed (high speed 750W vacuum pump included as standard)	
Cutting mat	Superior felt cutting underlay (one piece user replaceable) continuous belt	
Registration system	High speed CCD Camera	
Job recognition	Advanced QR code technology for instant file recognition and registration	

CUTTING CONTROL

Mountable tools	Tangential tools: Creasing Wheel with interchangeable wheels. Blade holder tool for 5mm blade. Perforation Wheel. Contour / Drag tools: Crease Ball tools. Blade holder tool for a selection of cutting blades
Force/Pressure	Tool 1 (Crease) up to 2,500gf (2.5kg). Tool 2 (Cut) up to 2,500gf (2.5kg). Tool 3 up to 1,300gf (1.3kg)
Recommended media thickness/types	Paper/card up to 800micron. Max. depth: 1000micron (low density substrate i.e., rice paper / softboard). 3mm EFGN fluted
Speed - three modes	Fast mode: 1,200mm/s. SD Standard mode: 960mm/s. HD: High quality mode: 750mm/s
Blades for label kiss cutting	1 x Yellow - 1mm 30° cemented carbide blade - for thin film and very soft material 1 x Red - 1mm 45° cemented carbide blade - for adhesive stickers, thin card under 0.25mm 1 x Blue - 1mm 60° cemented carbide blade - for rigid media, (polyester sheets)
Blades for card cutting (cut through)	3 x Red circlip - Industrial 1.4mm 45° circlip cemented carbide blade - default blade for cutting card stock and folding box board from 0.25 to 0.6mm thick 3 x Blue circlip - Industrial 1.4mm 60° circlip cemented carbide blade - use with high-intensity reflective film or magnetic media - suitable for cutting media from 0.5 to 1.2 mm thick (restricted to max limit of flatbed) 3 x Tangential blades - Industrial 5.5mm 45°
Creasing tools	Tangential: wheel crease tool with magnetic assist - variable pressure up to 2.5kg. Available in 5 widths for different media Passive: ball creasing tool; one narrow and one wide for different media or crease widths. Also used for 'debossing'
Pen holder	Pen, plotting pen, also used for calibration sensor
Output tray	Adjustable for different sheet sizes, moveable media collection tray

COMPATIBILITY MODE PC & Mac

ColorCut Pro – Plugin (PC) [§]	Adobe® Illustrator® CS6, CC2020 - CC2026 or CorelDRAW® 2017 - 2026 Graphics Suite
ColorCut Pro – Plugin (Mac Client) [§]	Adobe Illustrator® CC 2022 - 2026. Mac operating systems: Big Sur onwards
ColorCut Pro 5 Standalone (PC) [§]	Job server - enables jobs created by the ColorCut Pro Plugin above to be cut at any time
Specification [†]	Windows® 11 Pro x64 bit. 4GB of RAM (8GB recommended). Monitor res: 1280 x 720 minimum (1920 x 1080 recom.)

AUTO SHEET FEEDER

Maximum media size	530mm x 740mm
Minimum media size	197mm x 285mm
Maximum media weight / stack height	25kg or 210mm. 2,100 sheets (based on 80gsm).
Media pick up method	Quad (4) vacuum suction pads. Adjustable for portrait/landscape feeding
Sheet separation features	Sheet jog with forward facing air blade separation with additional stainless steel sheet fingers and air pulse knock down jet
Reverse side registration system	Patented additional 2 CCD camera systems to read sheet registration marks from rear side
Productivity indicator	4 Light bar indicator



POWER REQUIREMENTS

Power requirements - Cutter	220 - 240V / 6.8A / 700W
Power requirements - Vacuum pump	220 - 240V / 4.5A / 750W
Power requirements - ASF	Auto Sheet Feeder (supplied by cutter)
Power requirements - Compressor	220 - 240V / 3.6A / 750W (supplied with cutter)

[§] Does not support illegal copies of Illustrator.† Full version only. Does not support 'Home and Student', 'Essentials' edition, or illegal copies of CorelDRAW.

Technical Specification

FB9550 Pro^T Technical Specifications

CUTTER	Packed	Unpacked
Weight:	420kg	270kg
Length:	1,760mm	1,607.5mm
Width:	1,230mm	1,091mm
Height:	1,320mm	1,089mm
		
AUTO SHEET FEEDER	Packed	Unpacked
Weight:	265kg	180kg
Length:	1,580mm	1,331mm
Width:	1,060mm	922mm
Height:	1,400mm	1,207mm
		
MEDIA COLLECTION TRAY	Packed	Unpacked
Weight:	Included with cutter	18.5kg
Length:	Included with cutter	743mm
Width:	Included with cutter	663mm
Height:	Included with cutter	758mm
		

* Maximum dimensions relate to assembled machines and reflect full extremities of each device to allow for aspects such as tool beam and vacuum hose.

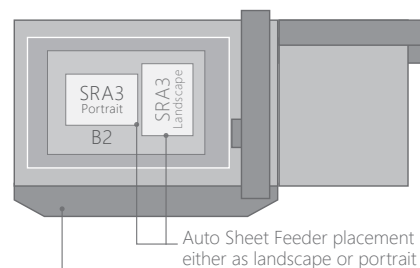
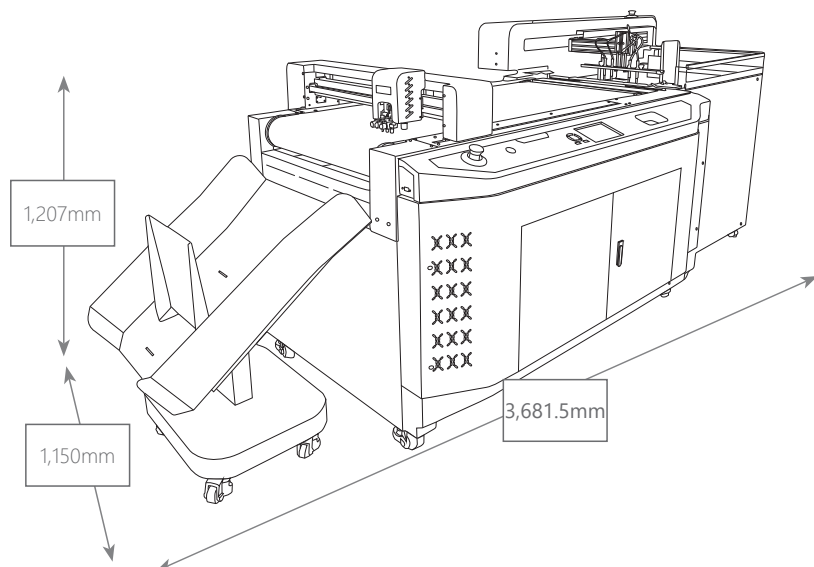

Maximum media size:
550mm x 850mm (manual placement)
530mm x 740mm (auto-feeder)

www.intecprinters.com • email: colorcut@plockmatic.com

*Disclaimer As part of our continued product improvement plan, specifications and information published here are subject to change without notice. All specifications are dependent on application, type of stock, temperature, RH and print engine used. Specifications quoted were measured on uncoated and unprinted stock. E & OE.